

ADAPTER SERIES

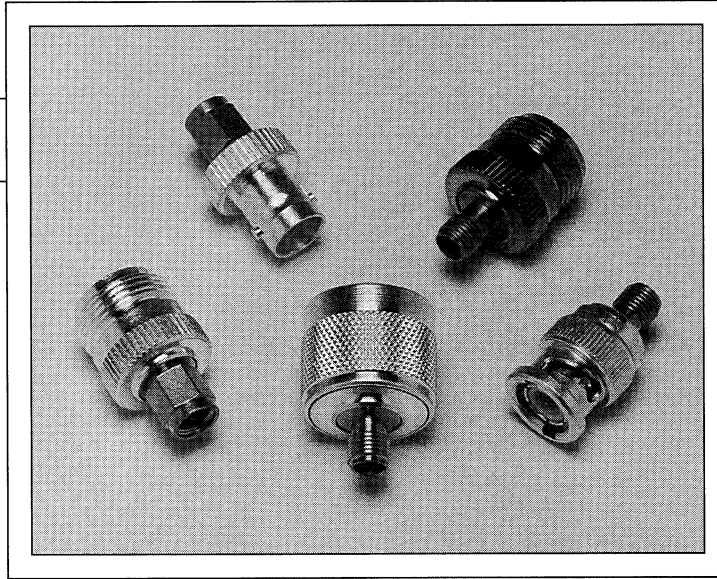

The Phoenix Company's Adapter Series is suitable for test and measurement applications and system requirements where different connector series are required to intermate. Each adapter provides an efficient, low loss transition, within a minimal amount of space. All components are machined using material consistent with the standard coax connector series. These coax adapters provide a cost effective solution, while offering a low VSWR and a broad frequency range, to meet all of your system and test requirements.

Adapters

Adapter Series	190
Specifications	191
Product Data	192-198

ADAPTERS

SPECIFICATIONS SUBJECT TO CHANGE WITHOUT NOTICE

SMA

MATERIALS

Bodies, Nuts: Corrosion Resistant Steel per ASTM A 582 & ASTM A 484.
Insulation: Teflon (PTFE) per ASTM D 1457.
Contacts, Male and Female: Beryllium Copper per ASTM B 196.
Gaskets: Silicone Rubber per ZZ-R-765.

BNC

MATERIALS

Bodies, Fittings, Male Center Contacts: Brass per ASTM B 16
Insulation: Teflon (PTFE) ASTM D 1457.
Contacts, Female: Beryllium Copper per ASTM B 196.
Contacts, Outer: Beryllium Copper per ASTM B 196.
Gaskets: Silicone Rubber per ZZ-R-765.

TNC

MATERIALS

Bodies, Fittings, Male Center Contacts: Brass per ASTM B 16
Insulation: Teflon (PTFE) ASTM D 1457.
Contacts, Female: Beryllium Copper per ASTM B 196.
Contacts, Outer: Brass per ASTM B 16.
Gaskets: Silicone Rubber per ZZ-R-765.

N

MATERIALS

Bodies, Fittings, Male Center Contacts: Brass per ASTM B 16
Insulation: Teflon (PTFE) ASTM D 1457.
Contacts, Female: Beryllium Copper per ASTM B 196.
Contacts, Outer: Beryllium Copper per ASTM B 196.
Gaskets: Silicone Rubber per ZZ-R-765.

PkZ[®] TO SMA / PDM TO SMA

MATERIALS

Bodies, Plugs: Brass per ASTM B 16.
Insulation: Teflon (PTFE) ASTM D 1457.
Retaining Ring: Beryllium Copper per ASTM B 194.
Contacts, Male: PkZ[®]: Beryllium Copper per ASTM B 196. PDM: Brass per ASTM B 16.
Contacts, Female: Beryllium Copper per ASTM B 196.
Gaskets: Silicone Rubber per ZZ-R-765.

PLATINGS

Stainless Steel Bodies: Gold per MIL-G-45204 or Passivated per MIL-F-14072.
Brass Bodies: Gold per MIL-G-45204 or Nickel Plated per QQ-N-290.
Contacts: Gold per MIL-G-45204.
Other Metal Parts: Plated or Passivated to meet the Environmental Requirements of MIL-C-39012.

PkZ[®] U.S. PATENT NO. 4,917,630 JAPANESE PATENT NO. 1769278



IN SERIES ADAPTERS

Part Number Gold	Part Number Passivated	SMA Plug/SMA Plug
2020-0000-00G	2020-0000-00P	

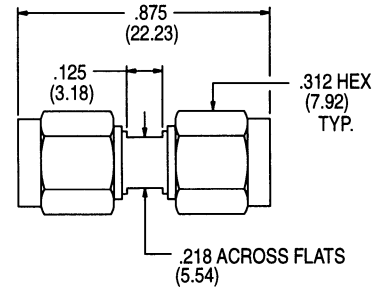

Part Number Gold	Part Number Passivated	SMA Plug/SMA Jack
2020-0100-00G	2020-0100-00P	

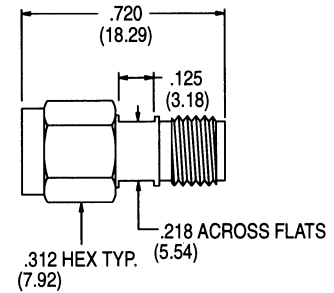

Part Number Gold	Part Number Passivated	SMA Jack/SMA Jack
2020-1100-00G	2020-1100-00P	

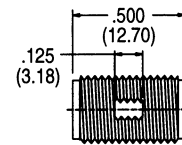

Part Number Gold	Part Number Passivated	SMA Jack/SMA Jack Panel Mount
2020-1165-00G	2020-1165-00P	

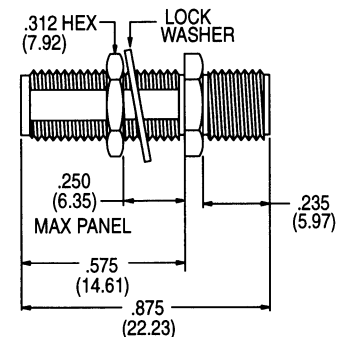

IN-SERIES ADAPTERS

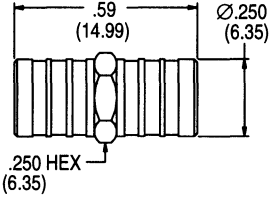
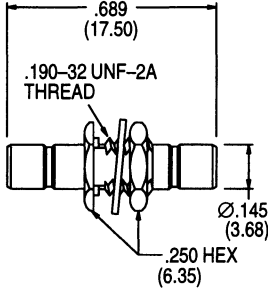
Part Number	0909-0000-00*	Part Number	0909-1180-00*
<p>Plug/Plug</p>  <p style="text-align: center;">.250 HEX (6.35)</p>	<p>Jack/Jack</p>  <p style="text-align: center;">.190-32 UNF-2A THREAD</p> <p style="text-align: center;">Ø.145 (3.68)</p> <p style="text-align: center;">.250 HEX (6.35)</p>		
Adapter	Adapter, Bulkhead Mount		See Mounting Data below

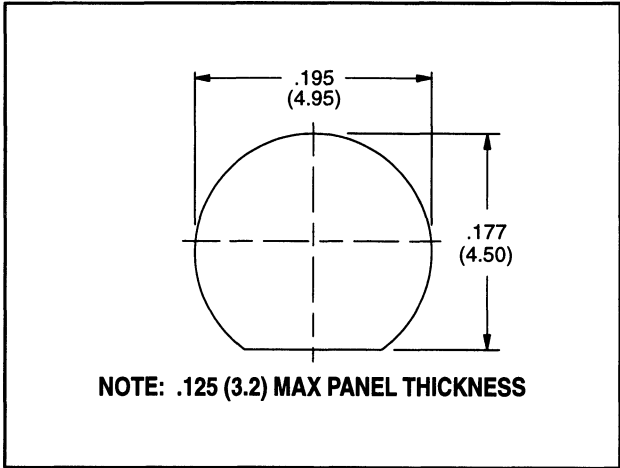

BETWEEN SERIES ADAPTERS

Part Number and Finish				SMA Plug/BNC Plug
SMA	BNC	SMA	BNC	
Gold	Gold	Passivated	Nickel	
2040-0000-00G/C		2040-0000-00P/N		

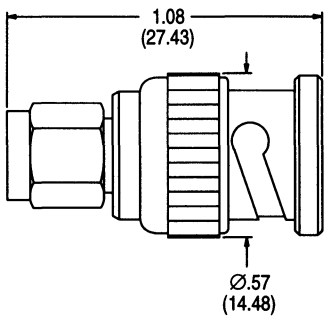

Part Number and Finish				SMA Plug/BNC Jack
SMA	BNC	SMA	BNC	
Gold	Gold	Passivated	Nickel	
2040-0100-00G/C		2040-0100-00P/N		

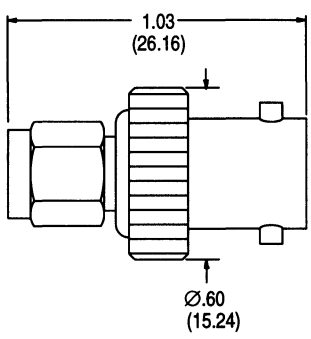

Part Number and Finish				SMA Jack/BNC Plug
SMA	BNC	SMA	BNC	
Gold	Gold	Passivated	Nickel	
2040-1000-00G/C		2040-1000-00P/N		

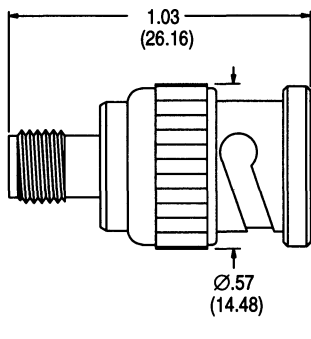

Part Number and Finish				SMA Jack/BNC Jack
SMA	BNC	SMA	BNC	
Gold	Gold	Passivated	Nickel	
2040-1100-00G/C		2040-1100-00P/N		

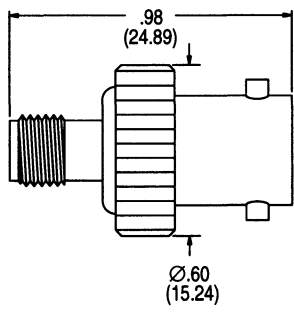

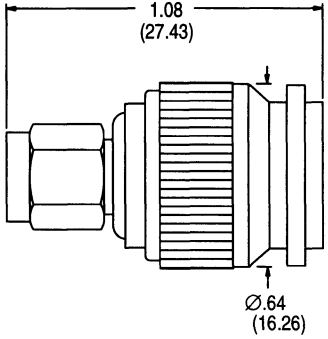

BETWEEN SERIES ADAPTERS

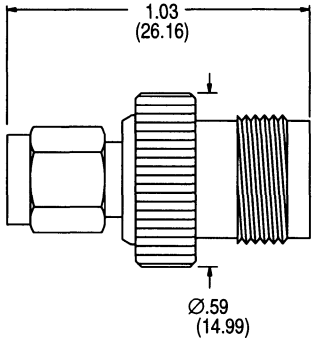
Part Number and Finish				SMA Plug/TNC Plug 
SMA	TNC	SMA	TNC	
Gold	Gold	Passivated	Nickel	
2041-0000-00G/C		2041-0000-00P/N		

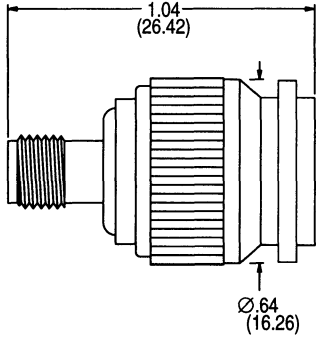
Part Number and Finish				SMA Plug/TNC Jack 
SMA	TNC	SMA	TNC	
Gold	Gold	Passivated	Nickel	
2041-0100-00G/C		2041-0100-00P/N		

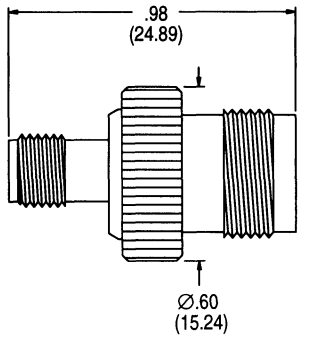
Part Number and Finish				SMA Jack/TNC Plug 
SMA	TNC	SMA	TNC	
Gold	Gold	Passivated	Nickel	
2041-1000-00G/C		2041-1000-00P/N		

Part Number and Finish				SMA Jack/TNC Jack 
SMA	TNC	SMA	TNC	
Gold	Gold	Passivated	Nickel	
2041-1100-00G/C		2041-1100-00P/N		



BETWEEN SERIES ADAPTERS

Part Number and Finish				SMA Plug/N Plug
SMA	N	SMA	N	
Gold	Gold	Passivated	Nickel	
2050-0000-00G/C		2050-0000-00P/N		

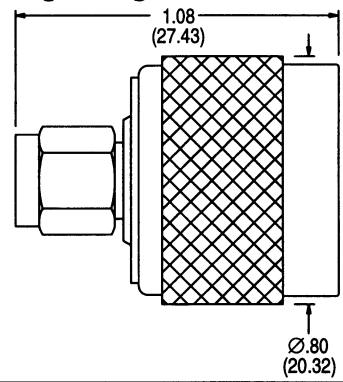

Part Number and Finish				SMA Plug/N Jack
SMA	N	SMA	N	
Gold	Gold	Passivated	Nickel	
2050-0100-00G/C		2050-0100-00P/N		

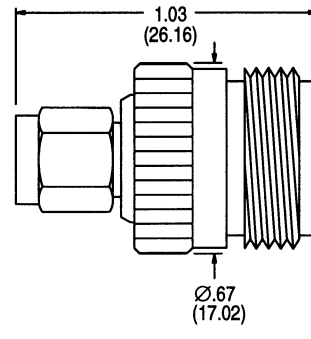

Part Number and Finish				SMA Jack/N Plug
SMA	N	SMA	N	
Gold	Gold	Passivated	Nickel	
2050-1000-00G/C		2050-1000-00P/N		

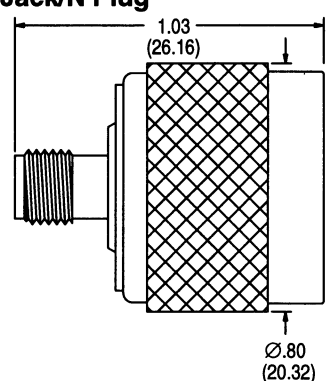

Part Number and Finish				SMA Jack/N Jack
SMA	N	SMA	N	
Gold	Gold	Passivated	Nickel	
2050-1100-00G/C		2050-1100-00P/N		

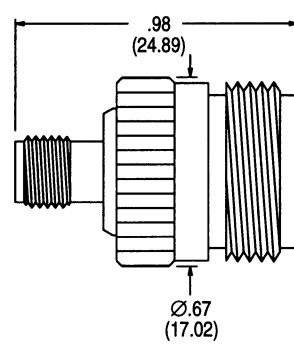

Part Number and Finish	
PKZ®	SMA
Gold	Gold
2620-0000-00G	
PKZ® Plug to SMA Plug Adapter	

Part Number and Finish	
PKZ®	SMA
Gold	Gold
2620-0100-00G	
PKZ® Plug to SMA Jack Adapter	

Part Number and Finish	
PKZ®	SMA
Gold	Gold
2620-1000-00G	
PKZ® Receptacle to SMA Plug Adapter	

Part Number and Finish	
PKZ®	SMA
Gold	Gold
2620-1100-00G	
PKZ® Receptacle to SMA Jack Adapter	

*See page 93 for ordering information.



BETWEEN SERIES ADAPTERS

Part Number and Finish	
SMA	PDM
Gold	Gold
2015-1000-00G	
SMA Jack/PDM Plug	

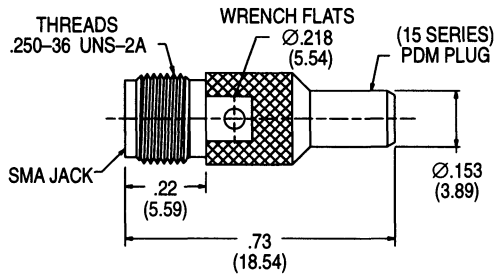

Part Number and Finish	
SMA	PDM
Gold	Gold
2024-1000-00G	
SMA Jack/PDM Plug (50 Ohm)	

